

DIMENSIONS

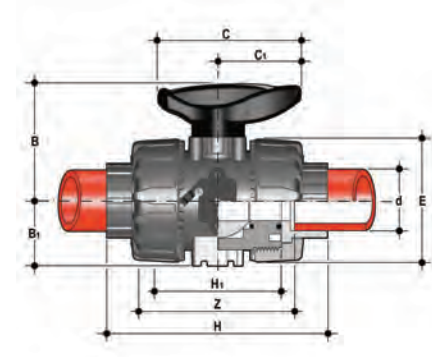

VKDIM

Dual Block® 2-way ball valve with female ends for socket welding, metric series

d	DN	PN	B	B ₁	C	C ₁	E	H	H ₁	Z	g	EPDM code	FKM code
16	10	10	54	29	67	40	54	102	65	74,5	150	VKDIM01E	VKDIM016F
20	15	10	54	29	67	40	54	102	65	73	145	VKDIM02E	VKDIM020F
25	20	10	65	34,5	85	49	65	114	70	82	218	VKDIM025E	VKDIM025F
32	25	10	69,5	39	85	49	73	126	78	90	298	VKDIM032E	VKDIM032F
40	32	10	82,5	46	108	64	86	141	88	100	480	VKDIM040E	VKDIM040F
50	40	10	89	52	108	64	98	164	93	117	682	VKDIM050E	VKDIM050F
63	50	10	108	62	134	76	122	199	111	144	1166	VKDIM063E	VKDIM063F

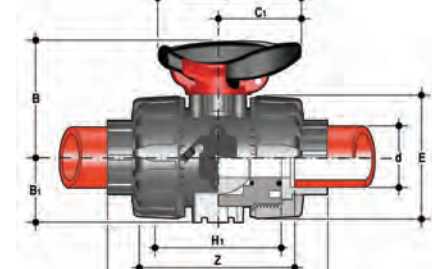

VKDIM/SHX

Dual Block® 2-way ball valve with handle lock and STAINLESS steel threaded inserts with female ends for socket welding, metric series

d	DN	PN	B	B ₁	C	C ₁	E	H	H ₁	Z	g	EPDM code	FKM code
16	10	10	54	29	67	40	54	102	65	74,5	160	VKDIMSHX016E	VKDIMSHX016F
20	15	10	54	29	67	40	54	102	65	73	155	VKDIMSHX020E	VKDIMSHX020F
25	20	10	65	34,5	85	49	65	114	70	82	228	VKDIMSHX025E	VKDIMSHX025F
32	25	10	69,5	39	85	49	73	126	78	90	308	VKDIMSHX032E	VKDIMSHX032F
40	32	10	82,5	46	108	64	86	141	88	100	490	VKDIMSHX040E	VKDIMSHX040F
50	40	10	89	52	108	64	98	164	93	117	692	VKDIMSHX050E	VKDIMSHX050F
63	50	10	108	62	134	76	122	199	111	144	1176	VKDIMSHX063E	VKDIMSHX063F

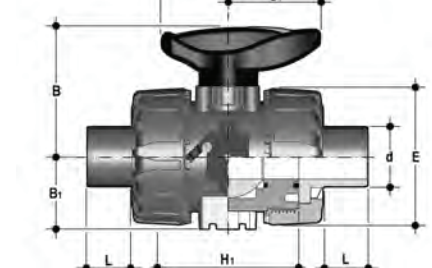

VKDDM

DUAL BLOCK® 2-way ball valve with male ends for socket welding, metric series

d	DN	PN	B	B ₁	C	C ₁	E	H	H ₁	L	g	EPDM code	FKM code
20	15	10	54	29	67	40	54	124	65	16	153	VKDDM020E	VKDDM020F
25	20	10	65	34,5	85	49	65	144	70	18	222	VKDDM025E	VKDDM025F
32	25	10	69,5	39	85	49	73	154	78	20	303	VKDDM032E	VKDDM032F
40	32	10	82,5	46	108	64	86	174	88	22	485	VKDDM040E	VKDDM040F
50	40	10	89	52	108	64	98	194	93	23	672	VKDDM050E	VKDDM050F
63	50	10	108	62	134	76	122	224	111	29	1176	VKDDM063E	VKDDM063F

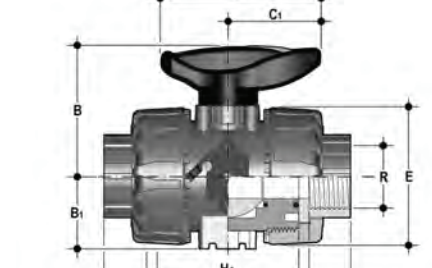

VKDFM

Dual Block® 2-way ball valve with BSP threaded female ends

R	DN	PN	B	B ₁	C	C ₁	E	H	H ₁	Z	g	EPDM code	FKM code
1/2"	15	10	54	29	67	40	54	110	65	15	80	VKDFM012E	VKDFM012F
3/4"	20	10	65	34,5	85	49	65	116	70	16	83	VKDFM034E	VKDFM034F
1"	25	10	69,5	39	85	49	73	134	78	19	96	VKDFM100E	VKDFM100F
1 1/4"	32	10	82,5	46	108	64	86	153	88	21	110	VKDFM114E	VKDFM114F
1 1/2"	40	10	89	52	108	64	98	156	93	21	113	VKDFM12E	VKDFM112F
2"	50	10	108	62	134	76	122	186	111	26	135	VKDFM200E	VKDFM200F

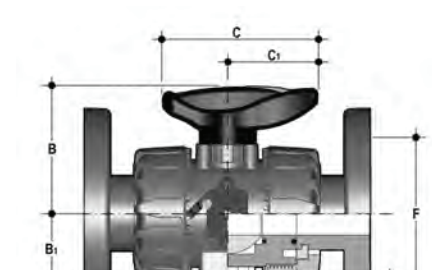

VKDOM

DUAL BLOCK® 2-way ball valve with fixed flanges, drilled EN/ISO/DIN PN 10/16. Face to face according to EN 558-1

d	DN	PN	B	B ₁	C	C ₁	F	f	H	H ₁	Sp	U	g	EPDM code	FKM code
20	15	10	54	29	67	40	65	14	130	65	11	4	387	VKDOM020E	VKDOM020F
25	20	10	65	34,5	85	49	75	14	150	70	14	4	504	VKDOM025E	VKDOM025F
32	25	10	69,5	39	85	49	85	14	160	78	14	4	697	VKDOM032E	VKDOM032F
40	32	10	82,5	46	108	64	100	18	180	88	14	4	1075	VKDOM040E	VKDOM040F
50	40	10	89	52	108	64	110	18	200	93	16	4	1346	VKDOM050E	VKDOM050F
63	50	10	108	62	134	76	125	18	230	111	16	4	2060	VKDOM063E	VKDOM063F

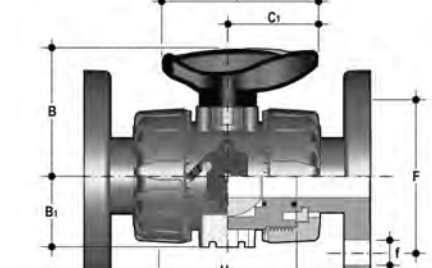

VKDOAM

DUAL BLOCK® 2-way ball valve with fixed flange, drilled ANSI B16.5 cl.150#FF

d	DN	PN	B	B ₁	C	C ₁	F	f	H	H ₁	Sp	U	g	EPDM code	FKM code
1/2"	15	10	54	29	67	40	60,3	15,9	143	65	11	4	387	VKDOAM012E	VKDOAM012F
3/4"	20	10	65	34,5	85	49	69,9	15,9	172	70	14	4	504	VKDOAM034E	VKDOAM034F
1"	25	10	69,5	39	85	49	79,4	15,9	187	78	14	4	697	VKDOAM100E	VKDOAM100F
1 1/4"	32	10	82,5	46	108	64	88,9	15,9	190	88	14	4	1075	VKDOAM114E	VKDOAM114F
1 1/2"	40	10	89	52	108	64	98,4	15,9	212	93	16	4	1346	VKDOAM112E	VKDOAM112F
2"	50	10	108	62	134	76	120,7	19,1	234	111	16	4	2060	VKDOAM200E	VKDOAM200F

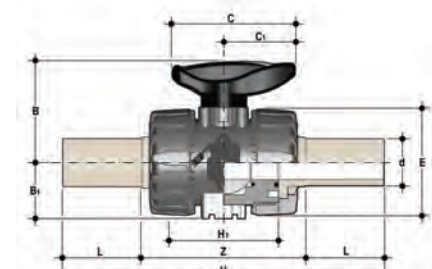

VKDBM

DUAL BLOCK® 2-way ball valve with long spigot male ends in PP-H SDR 11 for butt welding or electrofusion (CVDM)

d	DN	PN	B	B ₁	C	C ₁	E	H	H ₁	L	Z	g	EPDM code	FKM code
20	15	10	54	29	67	40	54	175	65	40,5	94	220	VKDBM020E	VKDBM020F
25	20	10	65	34,5	85	49	69,9	212	70	54	106	340	VKDBM025E	VKDBM025F
32	25	10	70	39	85	49	73	226	78	56	117	443	VKDBM032E	VKDBM032F
40	32	10	83	46	108	64	86	246	88	56	131	593	VKDBM040E	VKDBM040F
50	40	10	89	52	108	64	98	271	93	60,5	145	945	VKDBM050E	VKDBM050F
63	50	10	108	62	134	76	122	300	111	65,5	161	1607	VKDBM063E	VKDBM063F

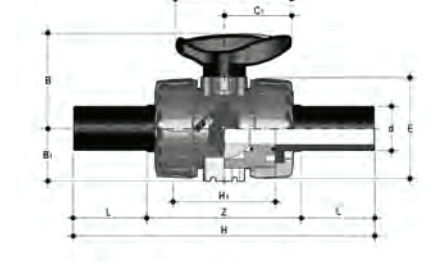

VKDBEM

DUAL BLOCK® 2-way ball valve with PE100 SDR 11 male end connectors for butt welding or electrofusion (CVDE)

d	DN	PN	B	B ₁	C	C ₁	E	H	H ₁	L	Z	g	EPDM code	FKM code
20	15	10	54	29	67	40	54	175	65	40,5	94	210	VKDBEM020E	VKDBEM020F
25	20	10	65	34,5	85	49	65	213	70	54	106	325	VKDBEM025E	VKDBEM025F
32	25	10	69,5	39	85	49	73	228	78	56	117	420	VKDBEM032E	VKDBEM032F
40	32	10	82,5	46	108	64	86	247	88	56	131	570	VKDBEM040E	VKDBEM040F
50	40	10	89	52	108	64	98	271	93	60,5	145	900	VKDBEM050E	VKDBEM050F
63	50	10	108	62	134	76	122	300	111	65,5	161	1500	VKDBEM063E	VKDBEM063F

ACCESSORIES

CVDM

End connectors in PP-H SDR 11 PN 10, long spigot, for butt welding

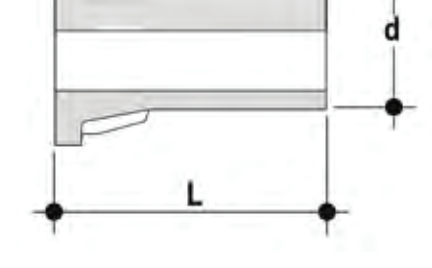

d	DN	PN	L	SDR	Code
20	15	10	55	11	CVDM11020
25	20	10	70	11	CVDM11025
32	25	10	74	11	CVDM11032
40	32	10	78	11	CVDM11040
50	40	10	84	11	CVDM11050
63	50	10	91	11	CVDM11063

CVDE

Long spigot PE100 end connectors for joints with electrofusion fittings or for butt welding



d	DN	PN	L	SDR	Code
20	15	16	55	11	CVDE11020
25	20	16	70	11	CVDE11025
32	25	16	74	11	CVDE11032
40	32	16	78	11	CVDE11040
50	40	16	84	11	CVDE11050
63	50	16	91	11	CVDE11063

SHKD

Handle block kit 0° - 90° lockable



d	DN	Code
16 - 20	10 - 15	SHKD020
25 - 32	20 - 25	SHKD032
40 - 50	32 - 40	SHKD050
63	50	SHKD063

PMKD

Wall mounting plate



d	DN	A	B	C	C ₁	C ₂	F	ff	1	S	Code
16	10	30	86	20	46	67,5	6,5	5,3	5,5	5	PMKD1
20	15	30	86	20	46	67,5	6,5	5,3	5,5	5	PMKD1
25	20	30	86	20	46	67,5	6,5	5,3	5,5	5	PMKD1
32	25	30	86	20	46	67,5	6,5	5,3	5,5	5	PMKD1
40	32	40	122	30	72	102	6,5	6,3	6,5	6	PMKD2
50	40	40	122	30	72	102	6,5	6,3	6,5	6	PMKD2
63	50	40	122	30	72	102	6,5	6,3	6,5	6	PMKD2

PSKD

Stem extension



d	DN	A	A ₁	A ₂	E	B	B ₁	B _{min}	Code
16	10	32	25	32	54	70	29	139,5	PSKD020
20	15	32	25	32	54	70	29	139,5	PSKD020
25	20	32	25	40	65	89	34,5	164,5	PSKD025
32	25	32	25	40	73	93,5	39	169	PSKD032
40	32	40	32	50	86	110	46	200	PSKD040
50	40	40	32	50	98	116	52	206	PSKD050